

User Manual

Color video door phone CDV-70KM



- Thank you for purchasing COMMAX products.
- Please carefully read this User's Guide (in particular, precautions for safety) before using a product and follow instructions to use a product exactly.
- The company is not responsible for any safety accidents caused by abnormal operation of the product.



Greetings

- Thank you for choosing COMMAX.
- Please read this manual carefully before you use the product.



Table of contents

Greetings	1
Table of contents	1
1. Warnings and caution	2
2. Product Overview	4
3. How to use	5
4. GUI Function	11
5. Wiring methods	27
6. Components	28
7. Caution in use	29
8. Miscellaneous	29
9. Specification	29

1. Warnings and caution

Please follow the things described below in order to prevent any danger or property damage.

	<h3>Warning</h3>	<p>It may cause a serious damage or injury if violated.</p>		<p>Prohibition.</p>
	<h3>Caution</h3>	<p>It may cause a minor damage or injury if violated.</p>		<p>No disassembly</p>
				<p>No touch</p>
				<p>Must follow strictly.</p>
				<p>Shows plugging out the power cord without an exception</p>
				<p>Shows the warning and caution for an electric shock.</p>
				<p>Shows the warning and caution for a fire.</p>

Warning

Power & Installation

Please don't use several products at the same time on one power socket.

- It may cause a fire due to an abnormal overheating.



Please don't bend the power cable excessively or it may cause an electric shock.

- fire when using a damaged power cable.

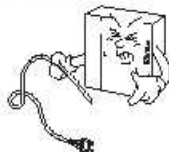

Please don't handle the power cable with a wet hand.

- It may cause an electric shock.

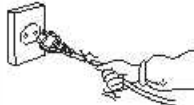

Please plug out the power cable from the socket when not using it for a long period of time.

- It may shorten the product lifespan or cause a fire.

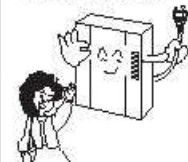

Please don't install the product in the place where there is much oil, smoke or humidity.

- It may cause an electric shock or fire.

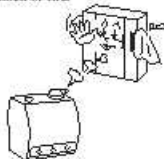

Please don't install the product with the lightning and thunder.

- It may cause an electric shock or fire.

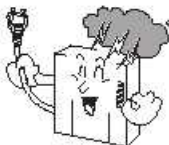

Please don't use and connect this product with other products with different rated voltage

- It may cause a disorder or fire.

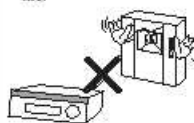

When installing the product that generates heat, please install the product away from the wall (10cm) for the ventilation.

- It may cause a fire due to the increased internal temperature.

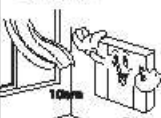

Warning

Cleaning & Use

Please don't disassemble, repair or rebuild this product arbitrarily (please contact the service center if a repair is needed).

- It may cause an electric shock or fire.



No disassembly



If an abnormal sound, burning smell or smoke is coming out of the product, please plug out the power cable and contact a service center.

- It may cause an electric shock or fire.



Please don't insert any metallic or burnable materials into the ventilation hole.

- It may cause an electric shock or fire.

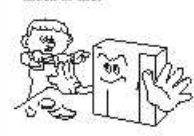

Please use only the designated batteries for the products of using DC power.

- It may cause an electric shock or fire.



Caution

Power & Installation

Please plug the power cable firmly into the inner end.

- It may cause a fire.

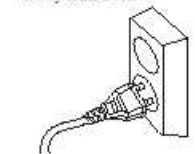

Please hold the plug tightly when unplugging the power cable (a part of the copper wire may be disconnected if the grabbing is only made on the cord when pulling out the cable).

- It may cause an electric shock or fire.



When connecting the power cables after cutting the cable, please install the product with power off.

- It may cause an electric shock or fire.

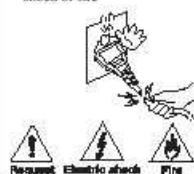

When installing the product, please fix it firmly while using the wall-mounting unit and screws.

- It may cause an injury from the falling object.



Please be careful when using an AC circuit breaker since there is a possibility of an electric shock.



Please check the use voltage and current for the DC-only products and use the appropriate rectifier.

- It may cause a fire.



Please avoid direct rays of the sun or heating devices at a time of installation.

- It may cause a fire.



Please don't install the product on an unstable place or small support board.

- It may cause an injury if it falls down while in use.

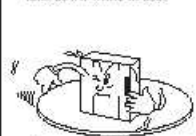

Cleaning & Use

When cleaning the product, please rub it with a soft and dry cloth after plugging out the power cable. (Please don't use any chemical products such as wax, benzene, alcohol or cleanser.)



Please don't drop the product on the ground and don't apply a shock.

- It may cause a failure.

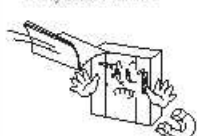

Please use the designated connection cable within the maximum calling distance designated for the product.

- It may reduce the product performance.





2. Product Overview

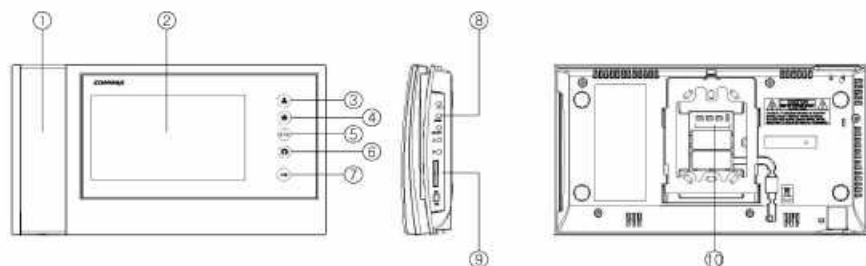

No.	Description	No.	Description
1	HANDSET	7	DOOR RELEASE BUTTON
2	LCD MONITOR	8	MENU BUTTON
3	MONITOR BUTTON	9	SD CARD SLOT
4	INTERPHONE BUTTON	10	EXTERNAL CONNECTION TERMINAL
5	VOLUME CONTROL		
6	IMAGE SAVE BUTTON		

- SHORT PIN is not used when Camera1 and Camera 2 are connected. Once the power is on, the product automatically detects whether the Camera 2 is connected or not.
- Therefore, please make sure that you connect CAMERA2 before the power is turned on, so that product can detect CAMERA2 connection.
(CAMERA2 is connected after the power is turned on, the videophone would not sense its connection, But it would sense the CAMERA2 after the CAMERA 2 calls the videophone.)



3. How to use



Stand-by mode

When you turn on the product, the LCD(Blue) on the upper right hand corner will be turned on.

And then you can see a LOGO on the LCD screen, after booting sound, it will be stand-by mode.

Operation

(1-1) To make a call

- ① When the visitor press button in stand-by mode from the entrance(door camera), electronic chime bell rings of video phone and interphone. And LEDs of  (Monitoring Button) and the image of the visitor is shown on the screen in 3 seconds.
- ② The screen will be turned on for 30 seconds and you can talk to the entrance unit when you pick up the handset. For communication, it will be turned on for 60 seconds.
- ③ The screen will be turned on for 30 seconds and for communication, it will be turned on for 60 seconds.
- ④  Icon will be popped up when the handset is picked up. If you press (Call)to call the interphone, interphone image will be shown on the screen and the beep sound will come out. If the handset of interphone is picked up, the conversation begins Put down the handset to end the conversation.
- ⑤ To call the videophone from the interphone, pick up the handset of interphone and press call button. Then, the videophone will ring and the interphone image will be shown on the screen.

(1-2) Call Function

If you would like to refuse the call from the entrance, press MENU button on the right sides of the product. Then, the call will end and return back to standby mode.

(2) VOLUME CONTROL (LOW → MEDIUM → HIGH → MUTE)

Press  button to adjust the volume in standby mode

When you press  button, the volume will be changed to (30 → 60 → 100 → MUTE).

- Initialization method and changing list
 - Initialization of settings(user initialization)
(All video files will be deleted after the initialization, therefore please make sure that you back up the saved video files before the initialization)
 - Color balance (BRIGHT 50/CONTRAST 50/COLOR 50)
 - Language(English)
 - Auto-save function (Auto-save)
 - Image save mode (Still image)
 - Deleted saved images of SD CARD.
-
- How to insert an SD card

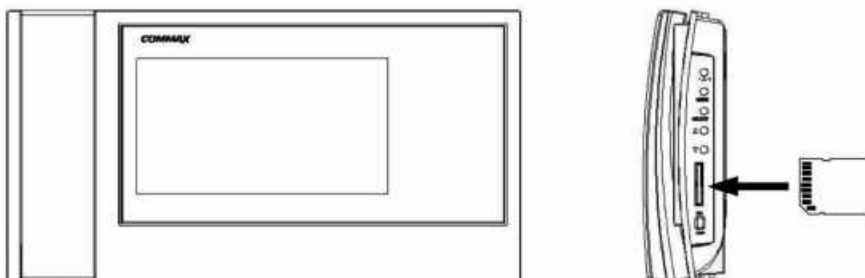

[CAUTION]

If the initialization is in progress, remove the SD card, or Do not turn OFF the power. SD card may cause a malfunction.



(3) Call Function

- ① If you press  (monitor button) in stand-by mode, LEDs blinks.
You can talk with door camera, if you pick up the handset
- ② You can talk for 60 seconds with door camera. When the time is over, it will be stand-by mode automatically.
- ③ You can talk with CAMERA2 by calling CAMERA2 during communicating with CAMERA1, the screen will be sequentially shown from CAMERA1 to CAMERA2 when user press (monitoring button)
- ④ When the visitor calls from the entrance(door camera) during communicating between video phone and interphone, the view from the camera will be displayed on

the screen and , 3-way communication begins..

※ Communication ends when the handsets are hung up.

(4) Save image

- ① To save camera images, press  (save image button) more than 1second during calling camera or monitoring mode.
- ② You can save still image shown on the screen when you press the button.
- ③ While it is saving the video clip, save image buttons will not work. The button will work after image saving is complete.
- ④ This function operates regardless of setting for recording method(Auto/manual)
- ⑤ You can use same function by pressing  for long when you call camera or monitoring.
- ⑥ Images are stored in SD CARD only. If you don't put in SD CARD or use defected SD CARD, saving images is not available.

(5) Monitoring

(The following scenario is the example that 2 cameras and 2 CCTV are installed. If they are not installed as like the example, the monitoring function of relevant camera doesn't work.)

- Monitoring sequence (The monitoring mode will be sequentially operated when user presses  button as follows)

(Standby mode)

- It will be sequentially operated when user presses monitoring button as follows.(Without CCTV connection)
- CAMERA1 → CAMERA 2 → OFF → CAMERA 1
- It will be sequentially operated when user presses monitoring button as follows. (With CCTV connection)
- CAMERA 1 → CCTV 1 → CAMERA 2 → CCTV2 → OFF
→ CAMERA 1

(During Communication)

No CCTV switch. - CCTV does not have communication function.

- It will be sequentially operated when user presses monitoring button as follows. (CAMERA1 → CAMERA 2 → CAMERA 1 → CAMERA



(6) Door release

- If you press  (door release button) on the monitor during the talk, the door opens with release sound.

(7) Save captured image

- ※ This function applies when the storage method is "Picture"

If you set auto-save mode, it store image when there is call from camera.

If you press  (save image button) or  (Monitoring) for 1second in monitoring mode or communicating mode, record icon will be displayed on the screen and 1image cut will be saved.

(8) Save of video

- ※ This function applies when the recording method is "video".

It record image when there is a call from camera in auto-recording mode.

If you set auto-save mode, it record video for 30 seconds when there is call from camera, and for 60 seconds in case of communicating.

The maximum time able to record video for one time is 90 seconds(reply time for call + time for talk)

[caution1]

Don't remove SD card during saving of captured image and video. It may cause defect or data loss.

[caution2]

The recording image file is only stored in SD CARD. Please note that It is not available to record image If SD CARD was defective or not put into product.

When the icon is displayed, please back up the files saved in the Micro SD Card.



SAVE FILE and FILE FORMAT

Still	image 000001C1.jpg		
	000002C2.jpg		
Video	000001C1.asf		
	000002C2.asf		
Details Of file	File No	Video Type	File Type
	000001 000002	C1 : CAM 1 C2 : CAM 2	Imagesimages → (*.jpg) Video → (*.asf)
Note	<p>→ It is necessary to keep minimum extra space of Micro SD Card Min. Extra Space: Micro SD - 5% ex) In case of 16GB, it requires 800MB</p> <p>→ Save 128 cuts(MAX) of Captured images If the memory exceed capacity, the oldest file will be deleted and then save new file.</p> <p>→ Video can be saved in full.. If not have any space for storage in Micro SD Card</p> <div style="text-align: center;">  </div> <p>This icon will be displayed in LCD screen.</p> <p>If the icon above comes up, the oldest file will be deleted automatically to save new one. At this time, it might erase several files to make minimum extra space. So, please make a backup of your important files and save separately. The icon "SD FULL" will be disappeared if there is enough space by format internal memory and Micro SD Card, delete files. The number of files is depends on memory. Please refer to following information. If the number of files exceed maximum number available to save, the oldest file will be deleted and save new one. Even though you have extra space.</p> <p>→ It is possible to delete all of files or each one.</p>		

The number of saving files for capacity

	Micro SDHC Card		
Capacity	4 GByte	8 GByte	16 GByte
Captured image	128 cuts	128 cuts	128 cuts
The number of Videos (60 second)	Max 380cuts	Max 750cuts	Max 1500cuts
Video time	About 380 min	About 750 min	About 1500 min



4. GUI Function

(1) Power On

When you turn on the product, "COMMAX" logo is displayed in the screen and it will automatically check if the SD card is equipped or not, During its checking, "SD CARD CHECKING." will be shown in the screen. The beep sound comes out when the setting is complete and it becomes stand-by mode.



(2) Main menu





Press Menu button at the side of the product to enter setting menu screen.

Main menu contains checking visitors / menu settings.

If you want to exit main menu, press menu button at the side of the product.



Button details











ICON	KEY	FUNCTION
		Select the "Checking Visitor"
		Select the "Setting Menu"

(3) Check recorded image (Checking visitor)

Select on between video and captured image.



Button details











ICON	KEY	FUNCTION
		Move Up
		Move Down
		Move right
		Select menu
		Move to main menu

(4) Checking recorded image

You can see each full image by selecting one in quad split-screen. It is possible to delete each one.



Button details



ICON	KEY	FUNCTION
		Move to next page
		Move to previous page
		Move among Quad split-screen
		Delete an image
		Move to top menu

(5) Delete image

If you implement [Current page Delete] function from Save Image check, you will see below images.



Button details





KEY	FUNCTION
	Select [Yes]
	Select [No]
	Show next page after deleting image

(6) Settings Menu

Time, Display, Language, Setting are adjustable.



Button details

KEY	FUNCTION
	Move right (Time → Display → Language → setting)
	Move left (Time ← Display ← Language ← setting)
	Select a menu
	Move top menu













(7) Time setting

When you see saving image it can be listed the time information.

It can be settled year/month/day/hour/minute. When you set, you can change only the blue that active. If you press the button you can change the actual time.

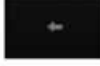

Button details











ICON	KEY	FUNCTION
		Moving the right
		Moving the left
		Select
		(If you press the select button) Time increase
		(If you press the select button) Time decrease
		Go to the top menu

(8) Screen Settings

You can adjust the brightness, contrast and color etc.



Button details

ICON	KEY	FUNCTION
		Moving the right
		Moving the left
		Select a menu
		It can be changed all settings to default. All setting will be initialized by 50.
		Go to the top menu









(9) Setting the Language

You can set the language menu. (All of base setting is in English)

When you move the key, please press the select button and it will be displayed V.



Button details







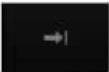

ICON	KEY	FUNCTION
		Moving the right
		Moving the left
		Select a menu
		Go to the top menu

(10) Settings menu

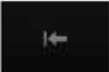
This menu can set Storage setting(still image/video), device initialization, automatically/manually saving setting, proximity sensor , electronics album.



Button details









ICON	KEY	FUNCTION
		Moving the right
		Moving the left
		Select a menu
		Go to the top menu

(11) Storage Setting

You can select saving image by calling camera. When you set the video, can make video and voice recording if set the stop image it will be saved the just image.



Button details

ICON	KEY	FUNCTION
		Moving the right
		Moving the left
		Select a menu
		Go to the top menu

(12) All initialization







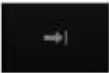

This function can initialization mode except time function.

All saved images on SD card will be deleted when it was full initialization, please do back-up all files before full initialization.

- Color balance (BRIGHT 50/CONTRAST 50/COLOR 50)
- Language (English)
- Auto-save function (Auto-save)
- Image save mode (Still image)
- Delete saved images of SD CARD.



Button details









ICON	KEY	FUNCTION
		Moving the right
		Moving the left
		Select a menu
		Go to the top menu

(13) Automatically / manually save settings





When you save the image, you can set auto mode and manual mode.



Button details

ICON	KEY	FUNCTION
		Moving the right
		Moving the left
		Select a menu
		Go to the top menu

(14) Interphone

When you press the button  below image will pop up, and  (interphone button) and  (talk button) will blink. Then press  (interphone button) to call the interphone as you can see the icon picture as followed. At the moment, if you press the (call) button below image will pop up, and call the interphone and it is possible to talk on the interphone.





Button details

KEY	FUNCTION
	Interphone call





(15) Camera Calling

When you press the call button in Camera or press  in videophone, the image of camera and CCTV will be appeared.

The left icon  tells the status of calling, The right icon  is the (stopped image) / and the right icon  is the image saving.



Button details

KEY	FUNCTION
	Standby mode: camera monitoring Camera call and status of monitoring : camera1/ camera 2 conversion Camera calling status : connect the call
	Interphone call to a third party call
	Call start / end
	Camera calling status : Save the image manually.
	Door open When you call the camera, you can just use.





(15) Door open.

When you call you can press the button  of open the door and then open.

The icon  will appear the screen.



Button details

KEY	FUNCTION
	Standby mode : Camera monitoring camera call and monitoring : camera1/ camera 2 Conversion camera call status : connect the call
	Interphone call to a third party call
	Call start / end
	Camera call and monitoring status: Save the image manually.
	Door open (When you call the camera, you can just use)



5. Wiring methods

Wiring is as bellow.

Camera connector polarity (4wires)

1. RED : sound signal
2. BLUE : GND
3. YELLOW : Power(+12V)
4. WHITE : image signal

CCTV Connector of polarity (2wires)

1. RED : Image signal
2. BLUE : GND

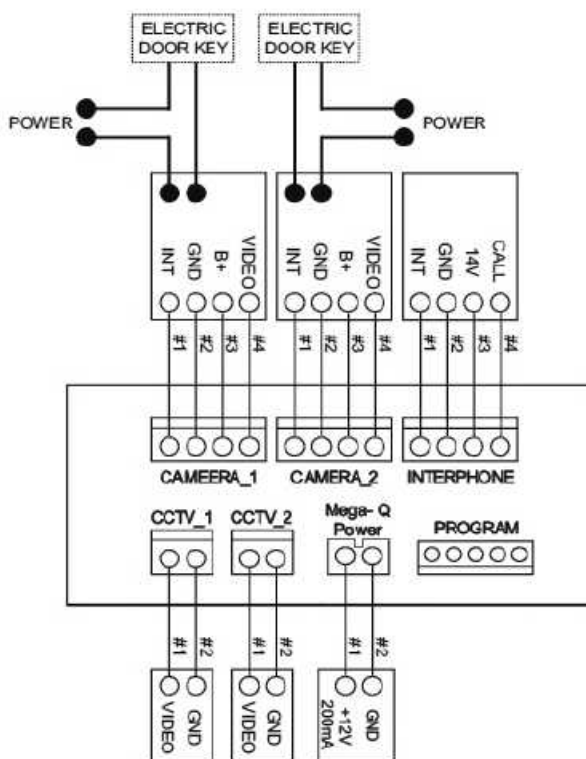

How to connect CCTV Camera

- Please supply separate power to CCTV CAMERA.
- Please select coaxial cable depending on the distance of the camera.

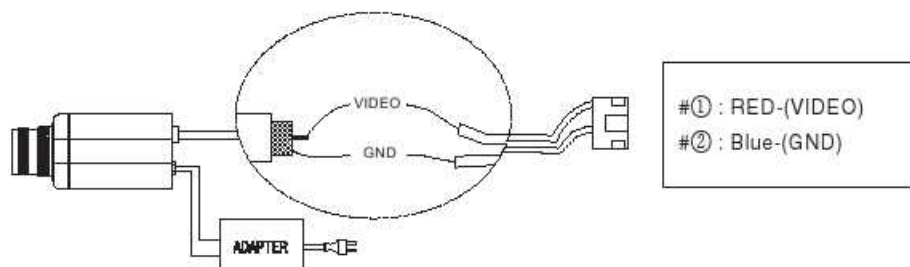

6. Components

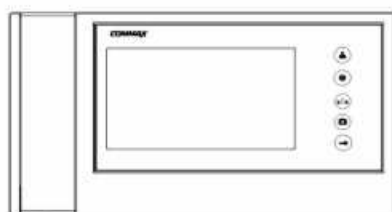

Monitor(CDV-70KM)



Wall Bracket



User Manual



Mounting screw
(4EA)



Monitor fixing screw
(1EA)



CCTV Camera
Connector
(2P x 2EA)



Door Camera Connector
(4P x 2EA)



InterPhone Connector
(4P x 1EA)



7. Caution in use

1. Turn on the power switch.
2. Please contact your local agent for product maintenance when you have a problem in use of CDV-70KM
3. For your safety, power switch with a safety device must be used in your building.
4. Unplug before installing or repairing the product.
5. Unplug when you connect monitor with door cameras.



8. Miscellaneous

- Please carefully read this User's Guide before calling service man
After checking the entire check list, please contact customer service center.
We will do our best to make you satisfy with our services.



9. Specification

MODEL	CDV-70KM		
Wiring	Door camera 4 wires (Polarity), CCTV 2wires(Polarity), Interphone 4wires(Polarity)		
Voltage	100-240V~, 50/60 Hz		
Power Consumption	Standby : 4.6W , in operation : 16W		
Communication	Full duplex (Hands-Set)		
Monitor	17.78Cm(7") TFT-DIGITAL LCD		
Ringling	- Entrance : Electronic chime (3 call 2times) - Interphone : Electron buzzer		
Video receiving period	Standby : 30 ± 5sec , response : 60 ± 5sec		
Distance	0.5mm	0.65mm	0.8mm
	28m	50m	70m
Temperature	0 ~ +40°C (32°F ~ 104°F)		
Dimensions(mm)	243.0(W) X 168.0(H) X 33.0(D)		

COMMAX

COMMAX Co.,Ltd.

513-11, Sangdaewon-dong, Jungwon-gu, Seongnam-si, Gyeonggi-do, Korea

Int'l Business Dept. Tel. : +82-31-7393-540~550 Fax. : +82-31-745-2133

Web site : www.commax.com

PM0270KM0010

Printed In Korea / 2013.10.104